

May 2001

ONKYO SERVICE MANUAL

USB Digital Audio Processor

SE-U55

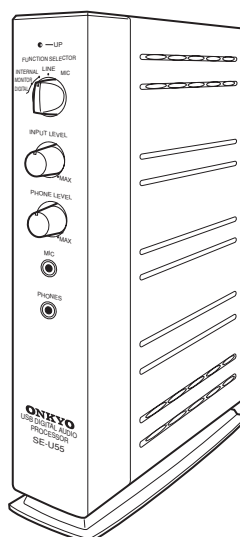

Main specifications

Type	USB digital audio processor
Connection method	USB (Universal Serial Bus Ver. 1.1)
Sampling rate	
Digital input	32/44.1/48 kHz compatible
Digital output	44.1 kHz
Frequency characteristics	0.3 Hz to 20 kHz (+0/-0.5 dB, LINE OUT)
Signal-to-noise ratio	100 dB (A-filter)
Total harmonic distortion	0.002% (1 kHz, 0 dB)
Output level	1.0 Vrms
Line input level	250 mVrms
Microphone input sensitivity	5.0 mVrms
Power supply	USB power supply, separately sold DC 7.5 V (exclusive adapter)
Current dissipation	400 mA
External dimensions	50 x 216 x 166 mm / 1 15/16" x 8 1/2" x 6 9/16"
Weight	0.7 kg / 1.5 lbs.

Specifications and external appearance are subject to change without notice.

Accessories

The SE-U55 comes supplied with the accessories shown below. Make sure that these accessories are present at the time of purchase. The number in parenthesis is the quantity of that accessory.



This instruction manual (1)

Explains operational procedures and the required settings for connecting the SE-U55 to your computer.



CarryOn Music instruction manual (1)

Instruction manual for using the supplied software CarryOn Music.



CD-ROM (1)

Contains the software for using the SE-U55 with a computer and an on-line instruction manual.

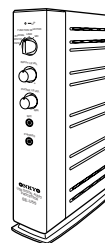

SE-U55 (1)

The USB digital audio processor. The SE-U55 converts your computer's sounds to professional-level high-quality audio sound.

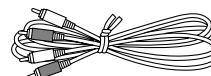

Audio pin-cord (1)

For the analog connection of the SE-U55 to external analog audio devices.

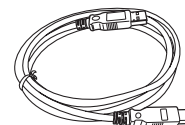

USB cable (1)

For the connection of the SE-U55 to your computer.

Registration Card (1)

Quick Setup guide (1)

Note:

The power supply for the SE-U55 is supplied through the USB cable from the connected computer.

CHASSIS-EXPLODED VIEW

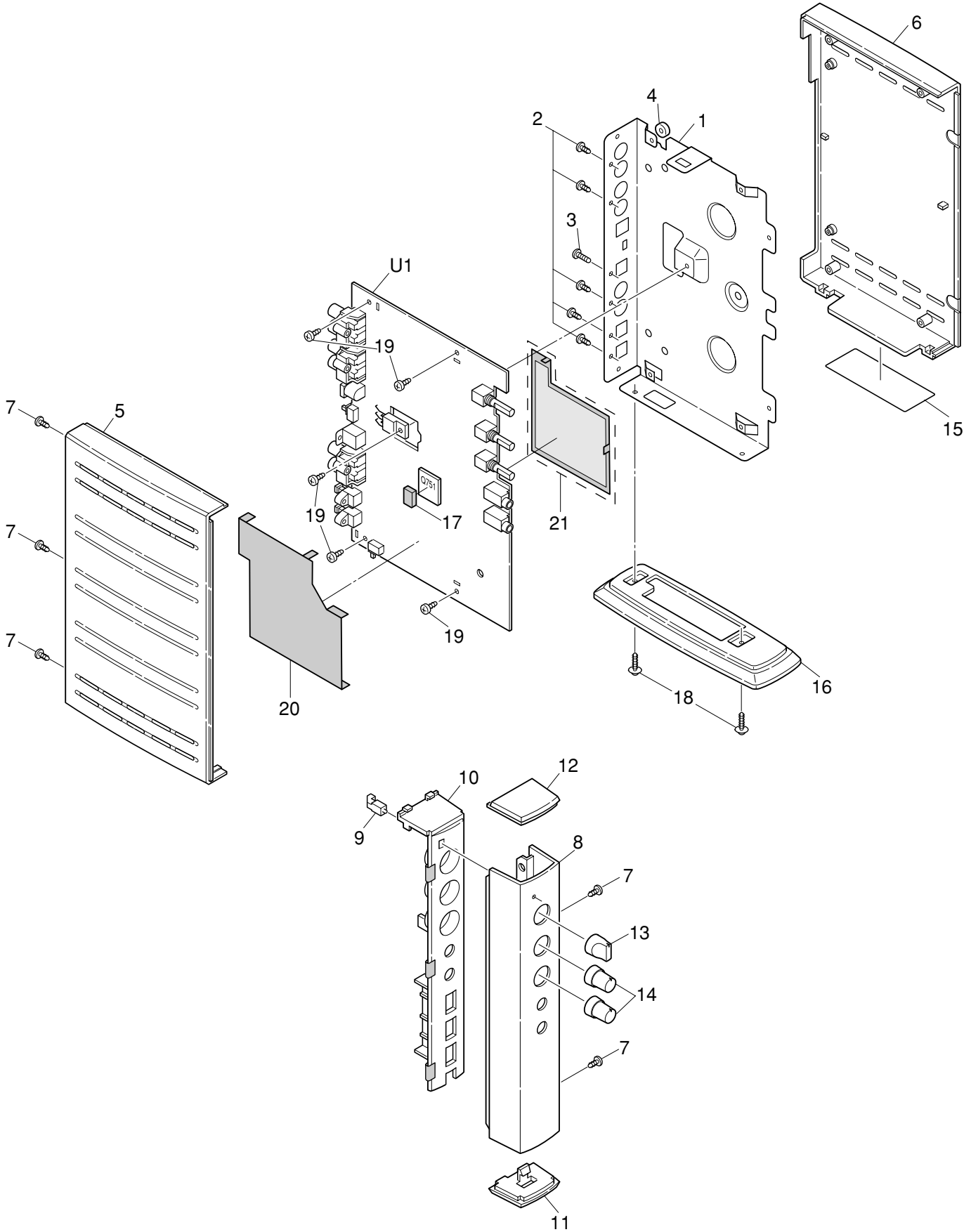

CHASSIS-EXPLODED VIEW PARTS LIST

REF NUMBER	DESCRIPTION	PART NUMBER
U1	PC BOARD AS, NAAR-7035-1C	1W223535-1C
1	CHASSIS	27100392
2	3TTB+8B(BC), SCREW	838430088
3	3P+10FN(BC), SCREW	82143010
4	SPACER M506RS	27270262
5	CASE, (L)	29105203
6	CASE, (R)	29105204
7	3TTB+8B(UN), SCREW	838930088
8	FRONT PANEL	27212266A
9	FACET, (SEL)	28198920
10	GUIDE, (VR)	27268034
11	END CAP, (L)	28125392
12	END CAP, (R)	28125394
13	KNOB, (SEL)	28325885
14	KNOB, (MIC)	28325884
15	LABEL, SPEC	29362847
16	STANDING AS	28163066
17	CUSHION, (DAC)	28141443
18	3SMS8W.SW+14B(BC), SCREW	801433
19	3TTB+8B, SCREW	838130088
20	SHLD PLT (U)	27150468
21	SHLD PLT (D) AS	27150467

SCHEMATIC DIAGRAM (INPUT SELECTOR : INTERNAL)

MODEL NO SE-U55/UE-155

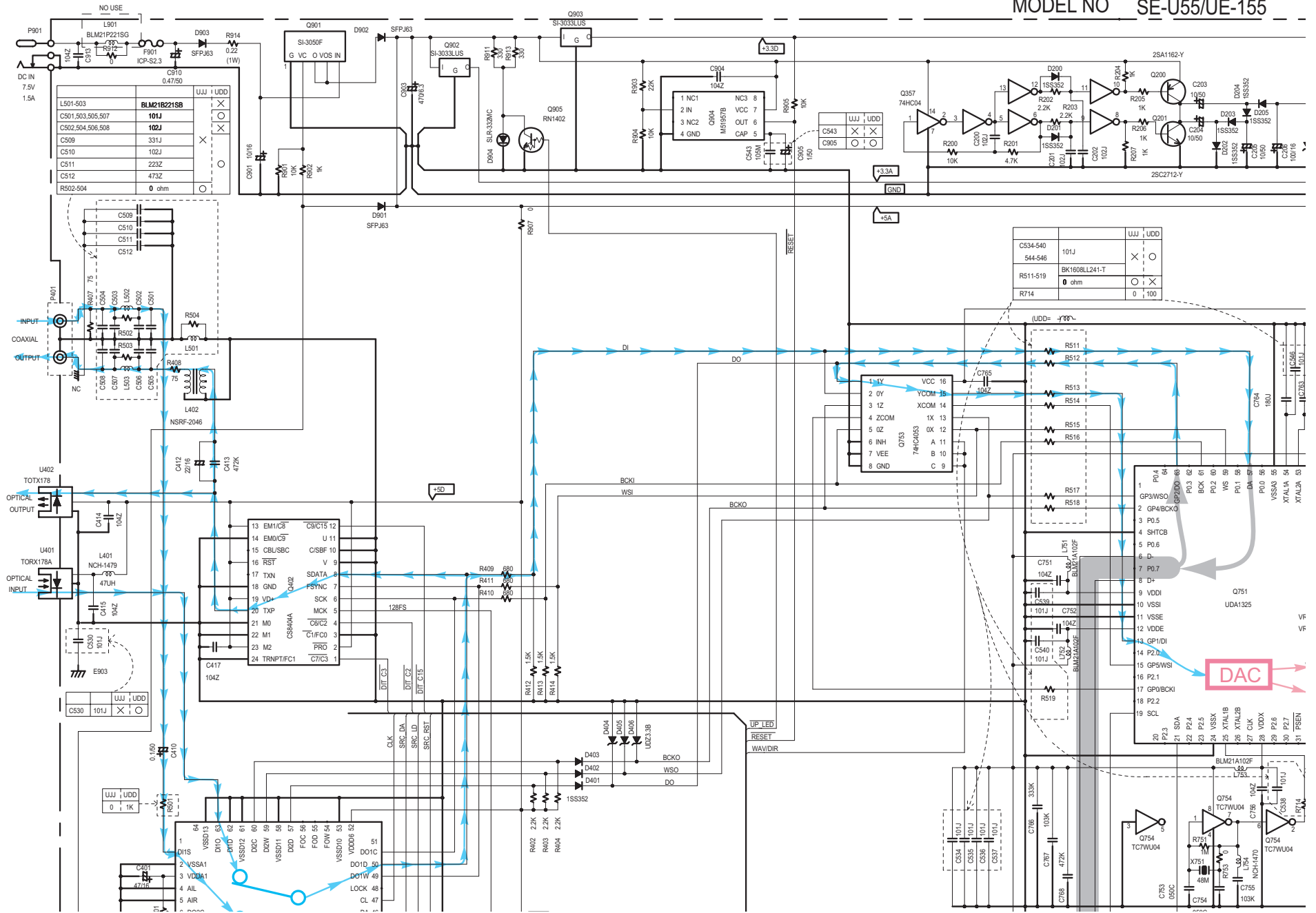

SCHEMATIC DIAGRAM (INPUT SELECTOR : INTERNAL)

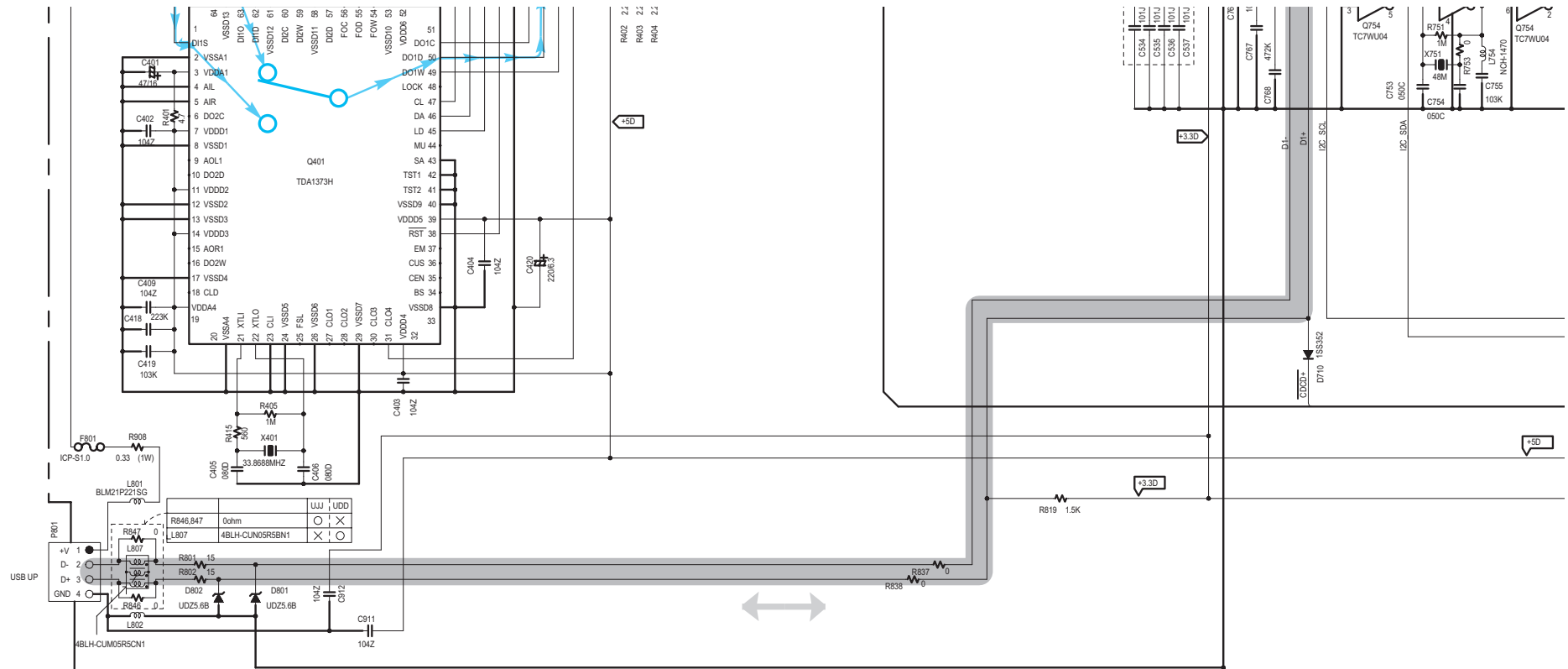

NOTE

- THE COMPONENTS IDENTIFIED BY MARK ARE CRITICAL FOR SAFETY. REPLACE ONLY WITH PART NUMBER SPECIFIED.
- VOLTAGE (MEASURED WITH VOLTMETER) IS DC VOLTAGE. (NO INPUT SIGNAL)
- ALL PNP TRANSISTORS ARE EQUIVALENT TO 2SA1015-GR UNLESS OTHERWISE NOTED.
- ALL NPN TRANSISTORS ARE EQUIVALENT TO 2SC1815-GR UNLESS OTHERWISE NOTED.
- ALL DIODES ARE EQUIVALENT TO 1SS133 UNLESS OTHERWISE NOTED.
- ELECTROLYTIC CAPACITORS () ARE IN μ F/WV.
- ALL CAPACITORS ARE IN pF/50V UNLESS OTHERWISE NOTED.
EX) 030-3pF 330-33pF 331-330pF 333-0.033 μ F
- ALL RESISTORS ARE IN OHMS 1/4WATTS UNLESS OTHERWISE NOTED.
- THE THICK LINES ON PC BOARD ARE THE PRINTING SIDE OF THE PARTS.
EX) PRINTING SIDE
- CIRCUIT IS SUBJECT TO CHANGE FOR IMPROVEMENT.

INPUT SELECTOR : INTERNAL

SCHEMATIC DIAGRAM (INPUT SELECTOR : INTERNAL)

JE-155 SCHEMATIC DIAGRAM

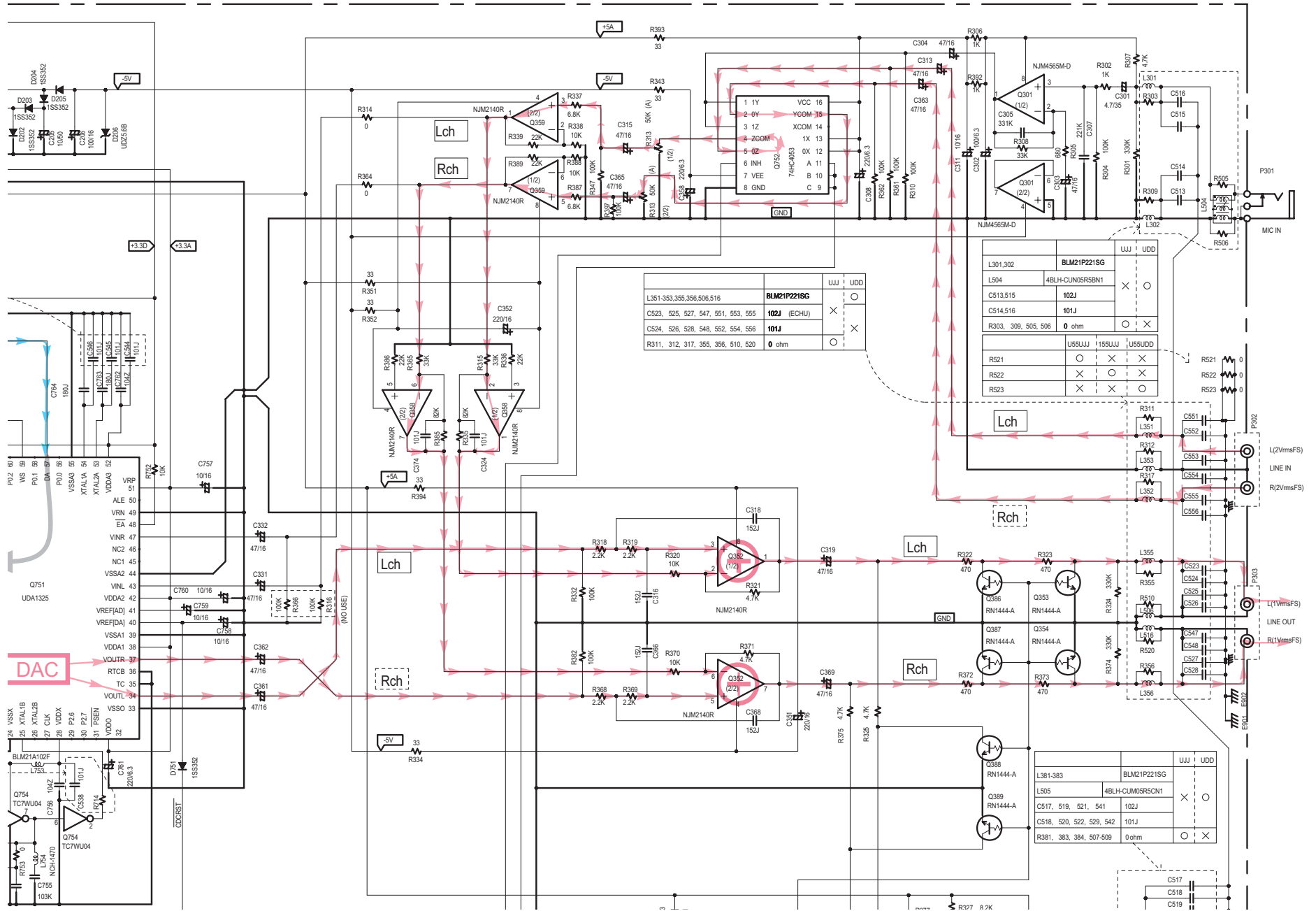

SCHEMATIC DIAGRAM (INPUT SELECTOR : LINE/MIC)

MODEL NO SE-U55/UE-155

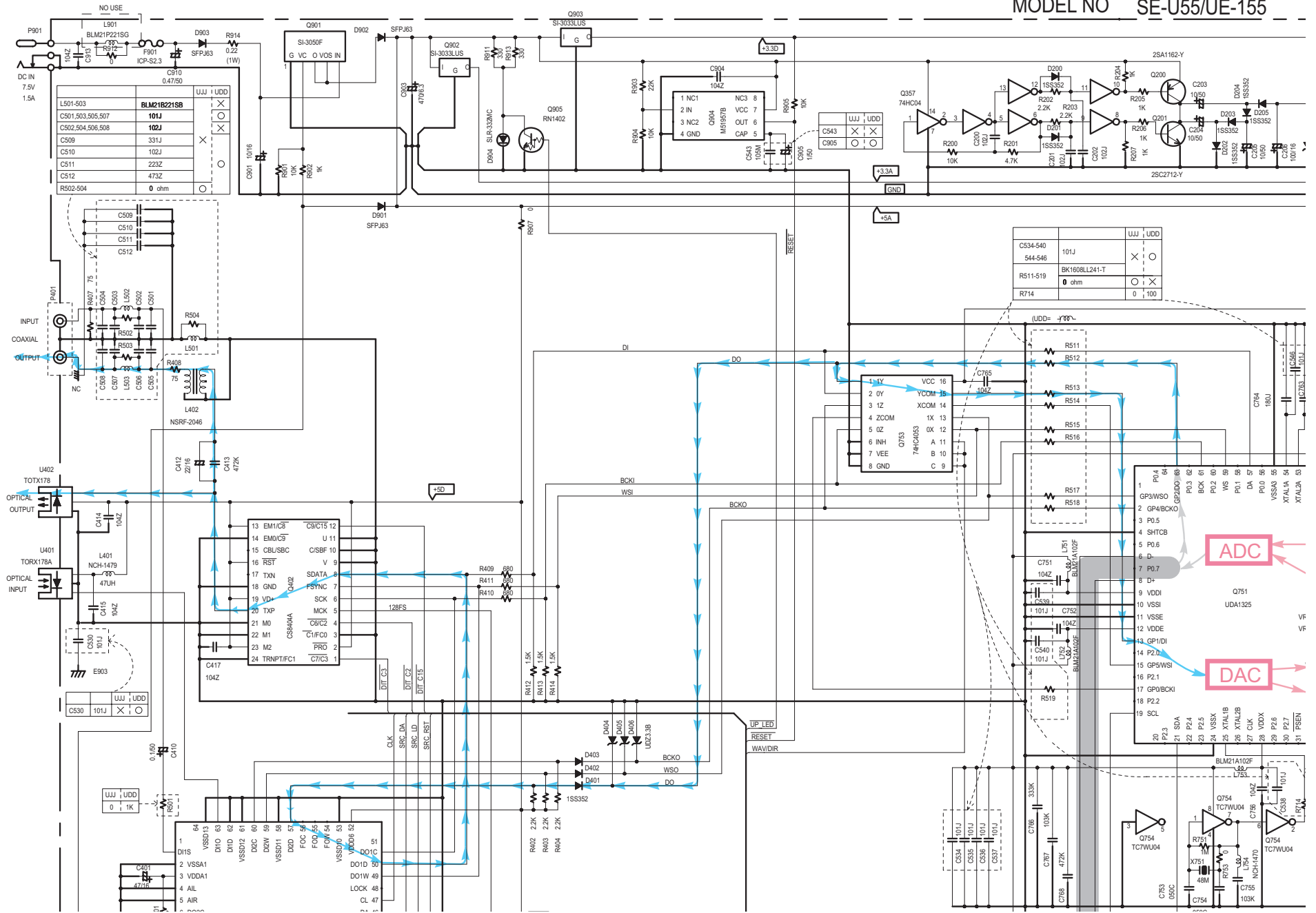

SCHEMATIC DIAGRAM (INPUT SELECTOR : LINE/MIC)

JE-155 SCHEMATIC DIAGRAM

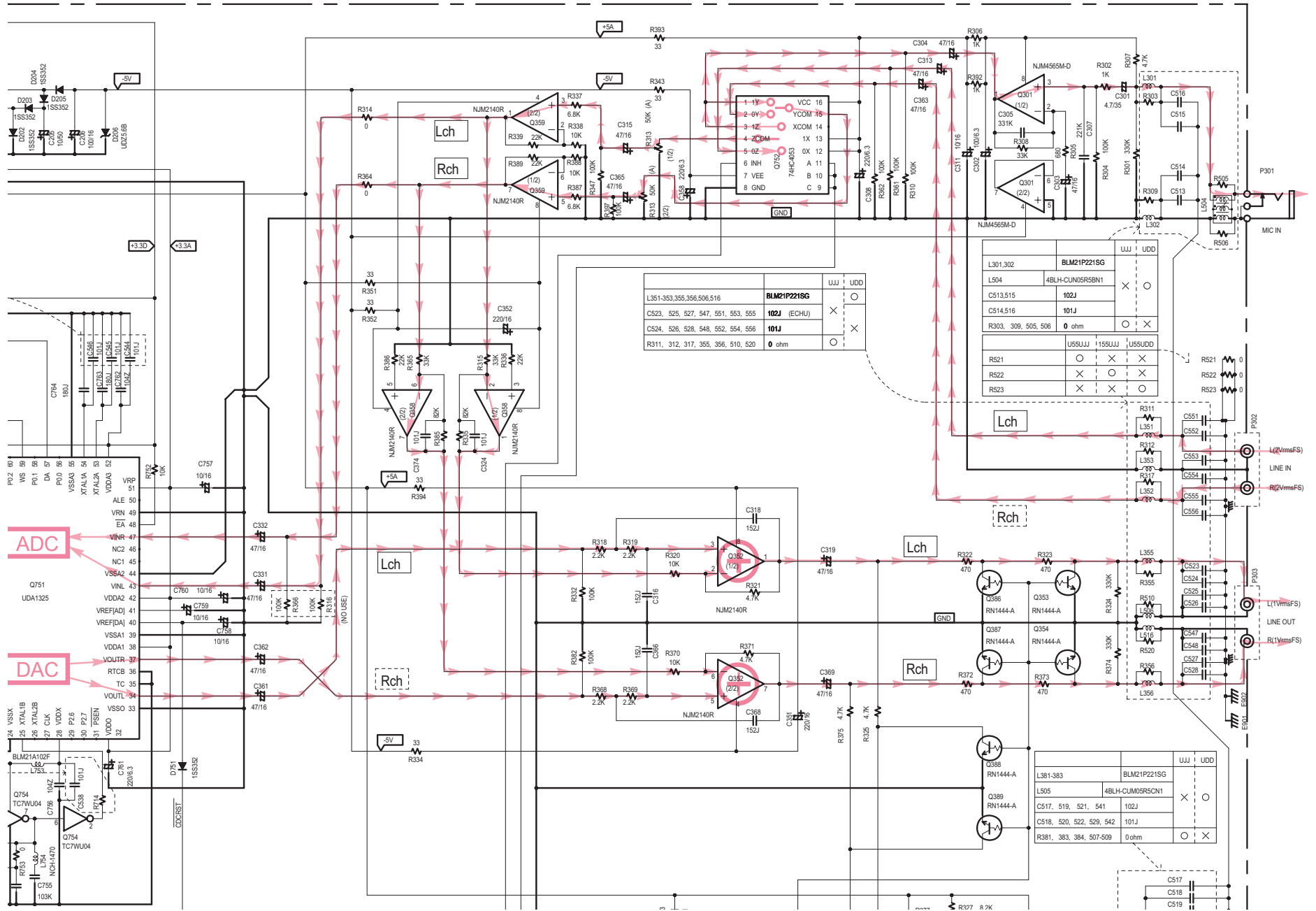

	UJ	UDD
L351-353, 355, 356, 506, 516		○
C523, 525, 527, 547, 551, 553, 555	×	
C524, 526, 528, 548, 552, 554, 556	101J	
R311, 312, 317, 355, 356, 510, 520	0 ohm	○

	UJ	UDD
L301,302		○
L504	4BLH-CUM05RSBN1	×
C513,515	102J	
C514,516	101J	
R303, 309, 505, 506	0 ohm	○

	U55UJ	U55UJ	U55UDD
R521	○	×	×
R522	×	○	×
R523	×	×	○

	UJ	UDD
L381-383		○
L505	4BLH-CUM05RSCN1	×
C517, 519, 521, 541	102J	
C518, 520, 522, 529, 542	101J	
R381, 383, 384, 507-509	0ohm	○

SCHEMATIC DIAGRAM (INPUT SELECTOR : LINE/MIC)

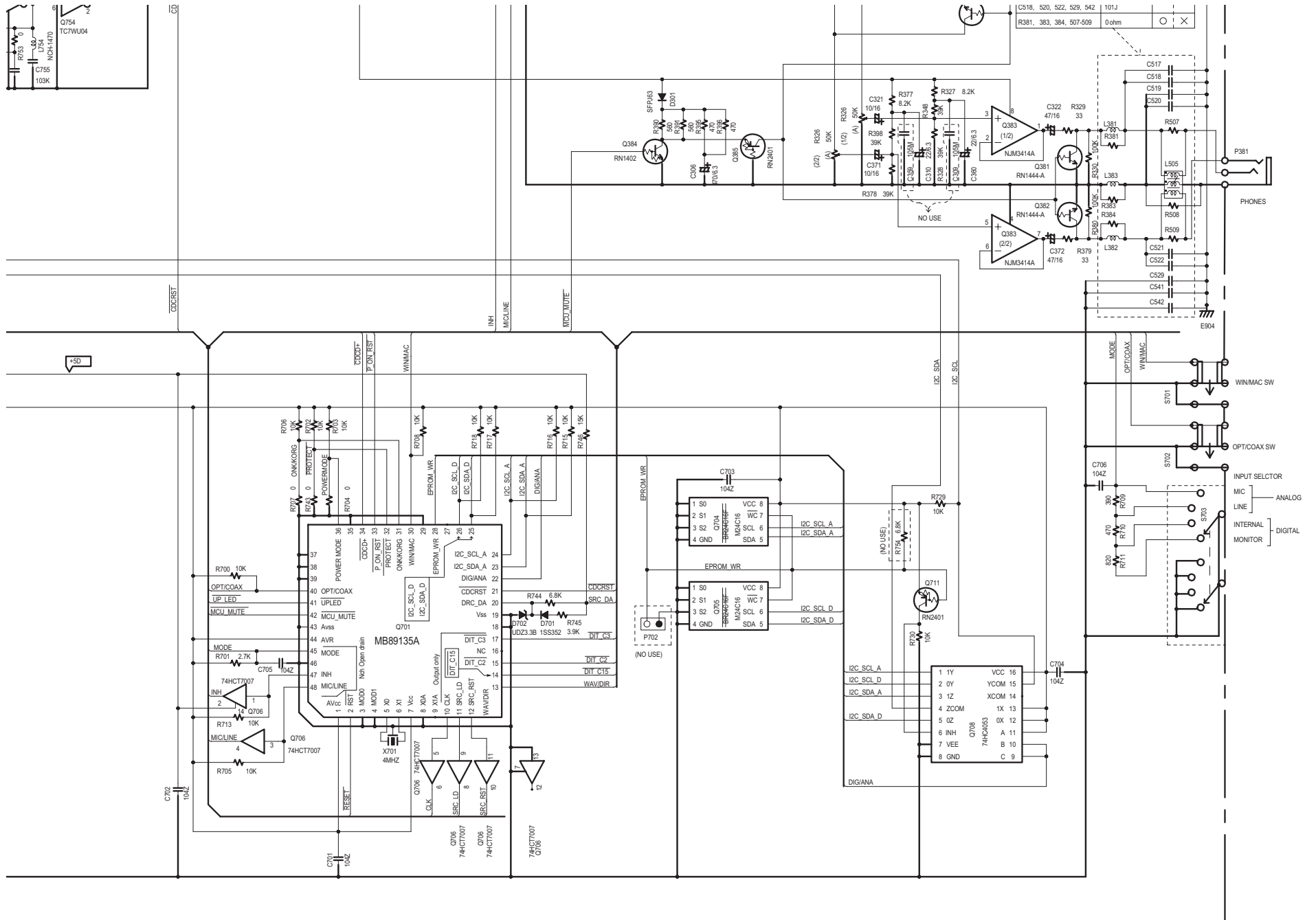



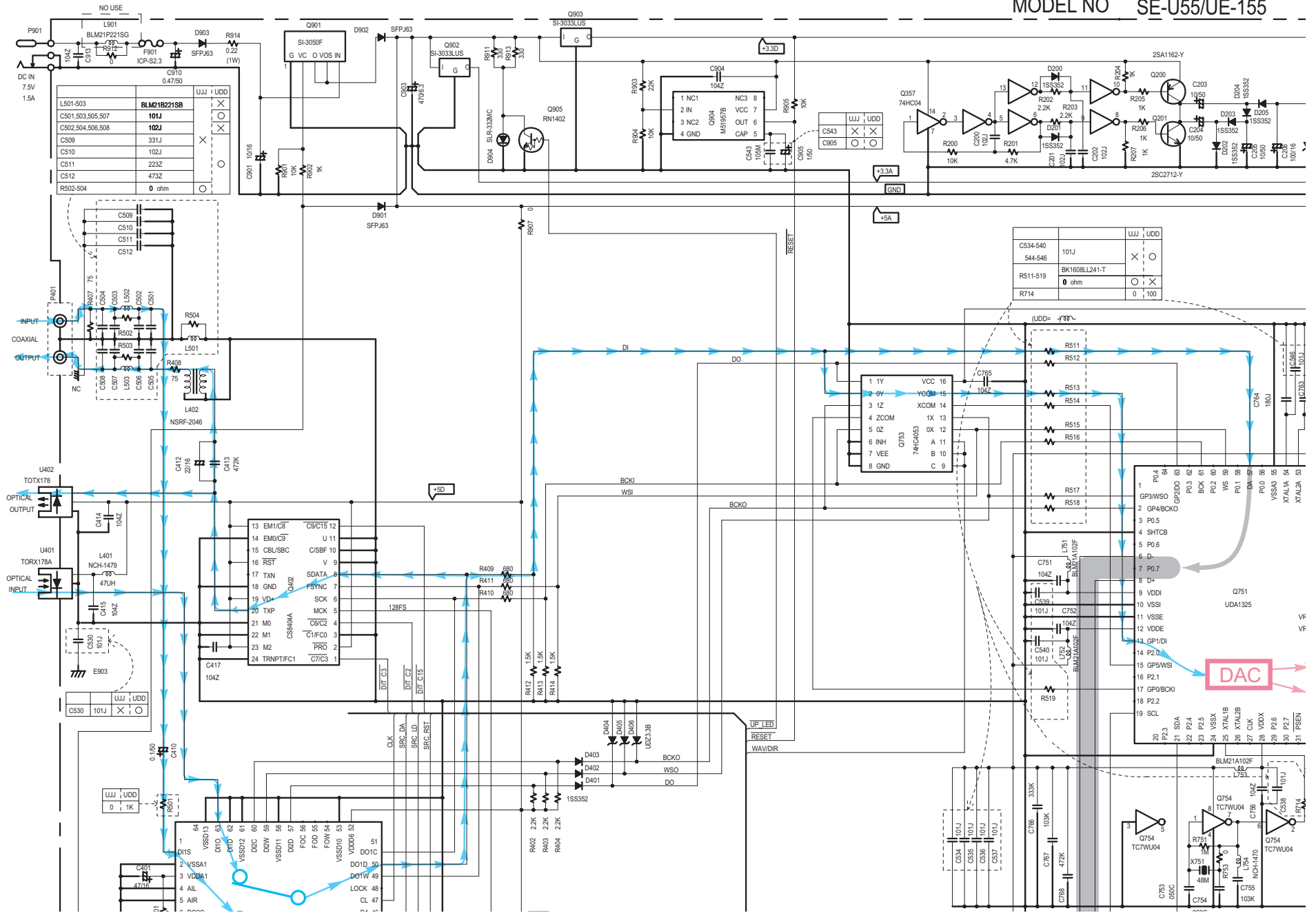

SCHEMATIC DIAGRAM (INPUT SELECTOR : MONITOR)

MODEL NO SE-U55/UE-155

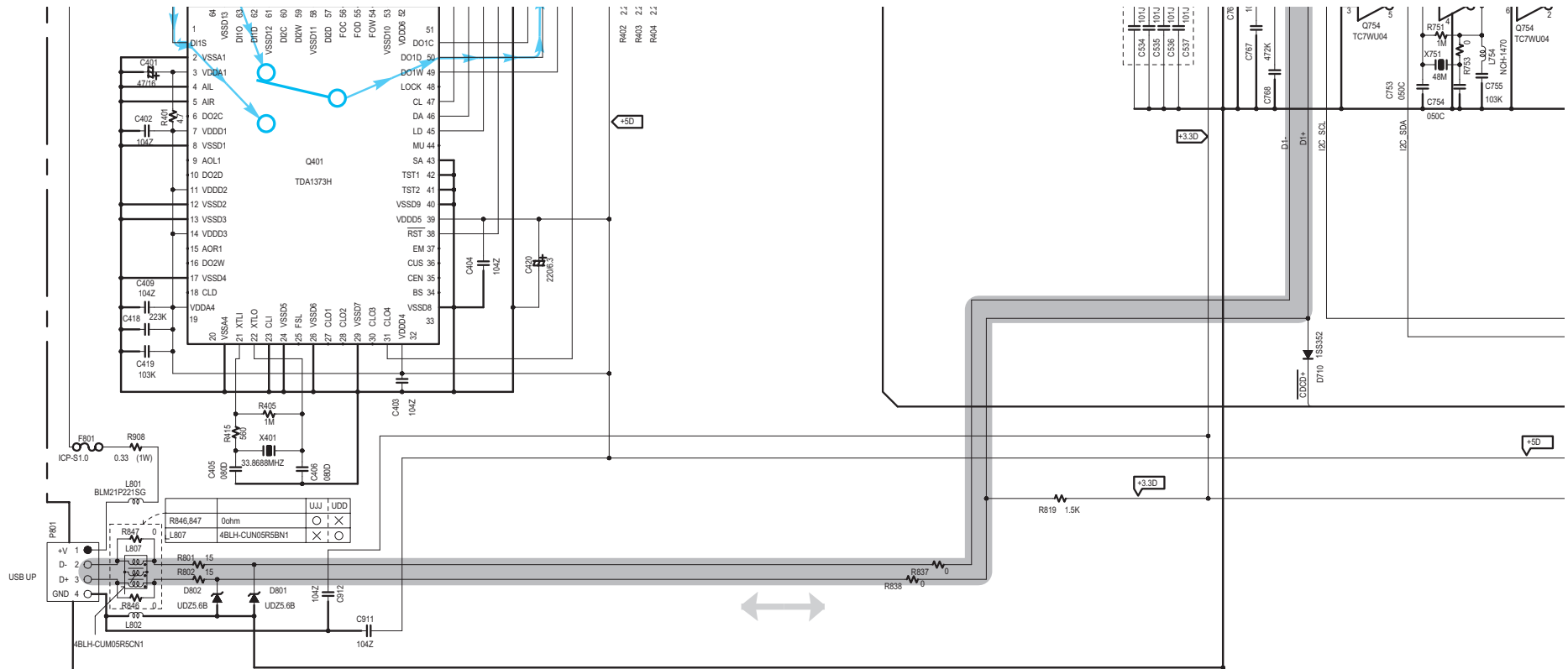

SCHEMATIC DIAGRAM (INPUT SELECTOR : MONITOR)



- NOTE**
- THE COMPONENTS IDENTIFIED BY MARK  ARE CRITICAL FOR SAFETY REPLACE ONLY WITH PART NUMBER SPECIFIED.
 - VOLTAGE (MEASURED WITH VOLTMETER)  IS DC VOLTAGE. (NO INPUT SIGNAL)
 - ALL PNP TRANSISTORS ARE EQUIVALENT TO 2SA1015-GR UNLESS OTHERWISE NOTED.
 - ALL NPN TRANSISTORS ARE EQUIVALENT TO 2SC1815-GR UNLESS OTHERWISE NOTED.
 - ALL DIODES ARE EQUIVALENT TO 1S133 UNLESS OTHERWISE NOTED.
 - ELECTROLYTIC CAPACITORS () ARE IN uF/WV.
 - ALL CAPACITORS ARE IN pF/50WV UNLESS OTHERWISE NOTED.
EX) 030 -3pF 330 -33pF 331 - 330pF 333 - 0.033uF
 - ALL RESISTORS ARE IN OHMS 1/4WATTS UNLESS OTHERWISE NOTED.
 - THE THICK LINES ON PC BOARD ARE THE PRINTING SIDE OF THE PARTS.
EX)  PRINTING SIDE
 - CIRCUIT IS SUBJECT TO CHANGE FOR IMPROVEMENT.

INPUT SELECTOR : MONITOR

SCHEMATIC DIAGRAM (INPUT SELECTOR : MONITOR)

JE-155 SCHEMATIC DIAGRAM

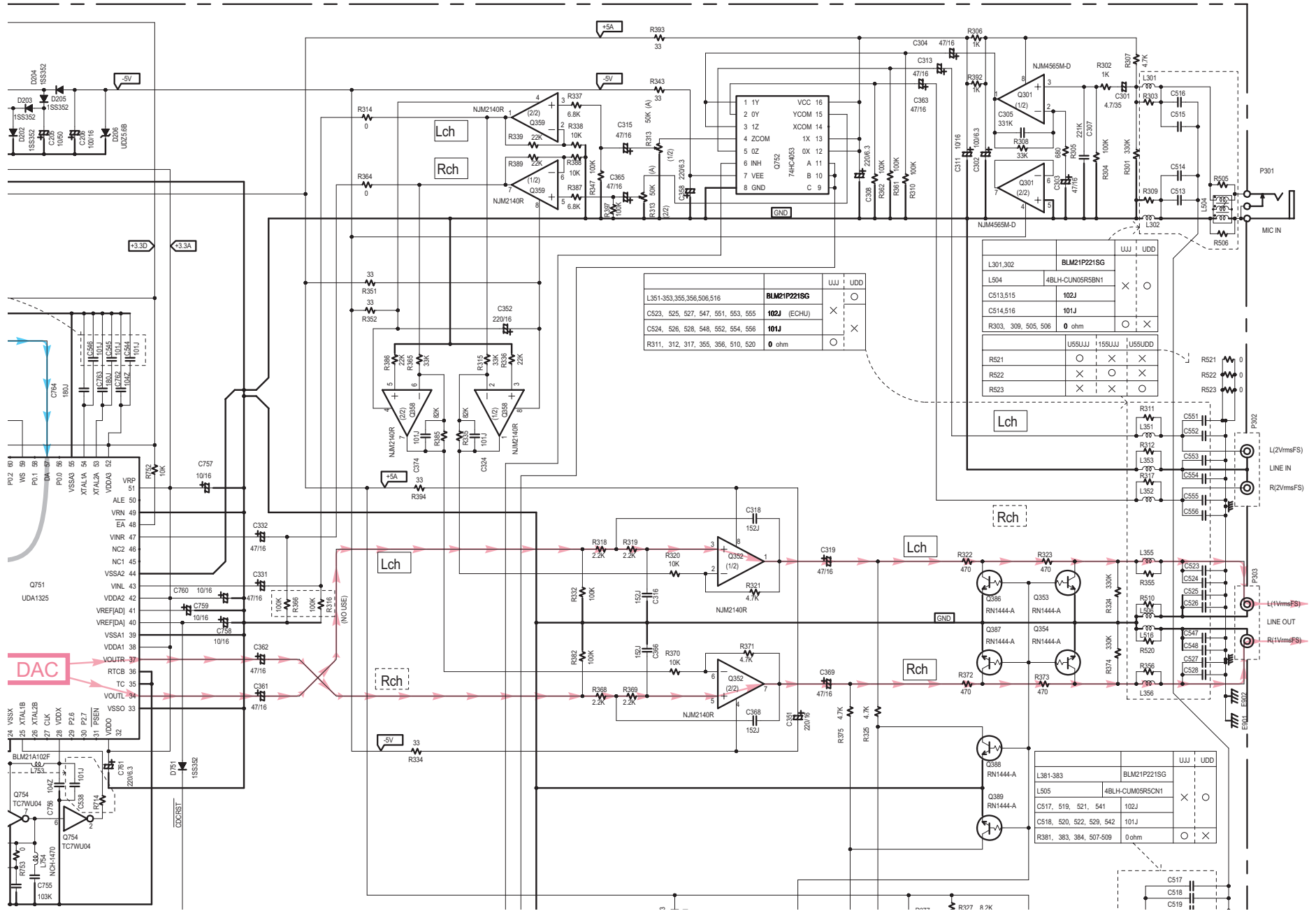

SCHEMATIC DIAGRAM (INPUT SELECTOR : MONITOR)

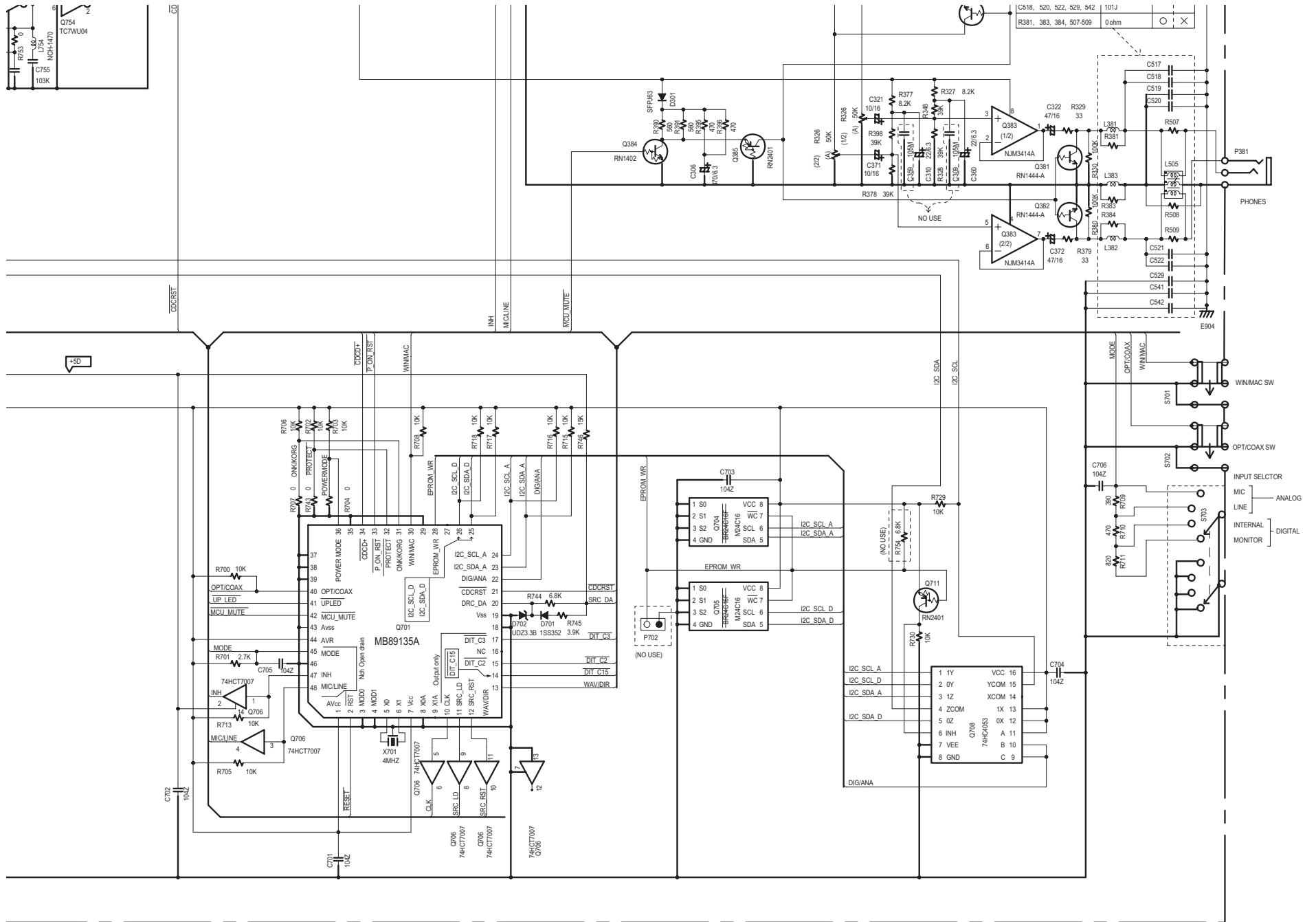

PC BOARD VIEW PARTS LIST

CIRCUIT NO.	DESCRIPTION	PART NUMBER	CIRCUIT NO.	DESCRIPTION	PART NUMBER
D200~D205	1SS352, C-DIODE or 1SS355, C-DIODE	223234R2 or 223269R2	Q711	RN2401, TR	2214520R2
D206	UDZ5.6B, ZENER D	224490560R2	Q751	UDA1325H, IC	22241312R3
D301	SFPJ-63, DIODE	223271R2	Q752, Q753	TC74HC4053FP, IC	22241228R2
D401~D403	1SS352, C-DIODE or 1SS355, C-DIODE	223234R2 or 223269R2	Q754	TC7WU04FU, IC	22240935R2
D404~D406	UDZ3.3B, ZENER D or RD3.3SB2, ZENER D	224490330R2 or 224370332R2	Q901	SI-3050F, IC	22241561
D701	1SS352, C-DIODE or 1SS355, C-DIODE	223234R2 or 223269R2	Q902, Q903	SI-3033LUS, IC	22278033CR2
D702	UDZ3.3B, ZENER D or RD3.3SB2, ZENER D	224490330R2 or 224370332R2	Q904	M51957BFP, IC	22241239R2
D710, D751	1SS352, C-DIODE or 1SS355, C-DIODE	223234R2 or 223269R2	Q905	RN1402, TR	2214470R2
D801, D802	UDZ5.6B, ZENER D	224490560R2	R313, R326	N09RGL50KA20F, VARI R	5112486
D901~D903	SFPJ-63, DIODE	223271R2	R511~R519	BK1608LL241-T, EMIFIL	230959R1
D904	SLR-332MC3F, LED	225332	R908	RNU1WCJ-0.33, METAL R	453633394
F801	ICP-S1.0, FUSE	252223R2	R914	RNU1WCJ-0.22, METAL R	453632294
F901	ICP-S2.3, FUSE	252226R2	S701, S702	NSS-22203, SLIDE SW	25065581
L301, L302	BLM21P221SG, CHOKE COIL	230949R2	S703	NRSF-224-20U, ROT SW	25030419
L351~L353	BLM21P221SG, CHOKE COIL	230949R2	U401	TORX178B, PHT CP	24120037
L355, L356	BLM21P221SG, CHOKE COIL	230949R2	U402	TOTX178A, PHT PARTS	24120031
L381~L383	BLM21P221SG, CHOKE COIL	230949R2	X401	HC-49U/03 33.8688MHz, CRYSTAL	3010325
L401	NCH-1479, CHOKE COIL	231237K470R2	X701	CST4.00MGW, CERA LOCK	3010150
L402	NSRF-2046, MPX COIL	232136	X751	HC-49/U03 48.000MHz, CRYSTAL	3010328
L501	BLM21B221SB, CHOKE COIL	230947R2			
L504, L505	NMBL-003, BLN COIL	233532R2			
L506, L516	BLM21P221SG, CHOKE COIL	230949R2			
L751~L753	BLM21A102F, CHOKE COIL	230948R2			
L754	NCH-1470, CHOKE COIL	231237M015R2			
L801, L802	BLM21P221SG, CHOKE COIL	230949R2			
L807	NMBL-003, BLN COIL	233532R2			
P301	YKB21-5181, JACK	25045579			
P302, P303	NPJ-2PDR446, PIN JACK	25045641			
P381	YKB21-5182, JACK	25045388			
P401	NPJ-2PDO445, PIN JACK	25045640			
P801	NSCT-4P2179, SOCKET	25052282			
P901	HEC0470-01-630, JACK	25045598			
Q200	2SA1162-Y, TR	2214374R2			
Q201	2SC2712-Y, TR	2213144R2			
Q301	NJM4565M-D, IC	22241383R2			
Q352	NJM2140R, IC	22241311R2			
Q353~Q354	RN1444-A, TR	2216031R2			
Q357	74HC04, IC	222740045R2			
Q358	NJM2140R, IC	22241311R2			
Q359	NJM2140R, IC	22241311R2			
Q381~Q382	RN1444-A, TR	2216031R2			
Q383	NJM3414AV, IC	22241469R2			
Q384	RN1402, TR	2214470R2			
Q385	RN2401, TR	2214520R2			
Q386~Q389	RN1444-A, TR	2216031R2			
Q401	TDA1373H, IC	22241428R3			
Q402	CS8404A, IC	22241429R2			
Q701	MB89135L-611, IC	22241557AR2			
Q704	M24C16-WMN6T, IC or BR24C16F, IC	22241431R2 or 22241430R2			
Q705	M24C16-WMN6T, IC or BR24C16F, IC	22241431R2 or 22241430R2			
Q706	TC74HCT7007AF, IC	222740077R2TO			
Q708	TC74HC4053FP, IC	22241228R2			

Microprocessor terminal descriptions

No.	Pin Name	I/O	Function
1	3.3V		+3.3V
2	RESET	I	Reset input (RESET:"L")
3	GND	I	GND
4	GND	I/O	GND
5	4MHz	I	External 4MHz clock input
6	4MHz	I	External 4MHz clock input
7	3.3V		+3.3V
8	GND		GND
9	X1A		Open
10	CLK	O	CLK signal output of SRC(TDA1373H)
11	SRC LD	O	LD signal output of SRC(TDA1371H)
12	SRC RESET	O	Reset output of SRC(TDA1373H)
13	WAV/DIR	O	CODEC output (WAVE or MONITOR) select signal output (WAVE : "H")
14	DIT C15	O	To DIT C15pin
15	DIT C2	O	To DIT C2pin
16	(NO USE)	O	Open
17	DIT C3	O	To DIT 3pin
18	(NO USE)	I	GND
19	GND		GND
20	SRC DA	I/O	Serial data of SRC81373H) input/output
21	CODEC RST	I/O	To VREF of USB CODEC(UDA1325)
22	DIG ANA	O	EEPROM for USB CODEC select signal output
23	I2C SDA A	I/O	SDA port for EEPROM writing.
24	I2C SCL A	I/O	SCL port for EEPROM writing.
25	I2C SDA D	I/O	SDA port for EEPROM writing for DIGITAL setup. Usually, it considers as an input and becomes SDA input and output at the time of writing.
26	I2C SCL D	I/O	SCL port for EEPROM writing for DIGITAL setup. Usually, it considers as an input and becomes SCL output at the time of
27	(NO USE)	I	GND
28	EPROM WR	I/O	EEPROM write-in control port. Usually, it is an input port, and immediately after reset, when this is "L", "L" is outputted and EEPROM is written in.
29	(NO USE)	I	GND
30	MAC/WIN	I	The setting switch (H:WIN, L:MAC) of WIN/MAC.
31	ONK/KORG	I	Copyright output protection. (H:normal mode)
32	PROTECT	I	Existence of copyright protection information. (H:normal mode)
33	PON RST	O	Power-on reset.
34	CODEC D+	I/O	D+ of USB CODEC (UDA1325) is controlled. Usually, it is "H" and D+ is grounded through a diode by "L."
35	(NO USE)	I	GND
36	POWER MODE	I	A setup of POWER MODE of USB. L: BUS POWER H:SELF POWER.
37	(NO USE)	I	GND
38	(NO USE)	I	GND
39	(NO USE)	I	GND
40	OPT/COAX	I	The change switch of OPTICAL and COAXICAL. H: COAXICAL and L:OPTICAL.
41	UPLD	O	Light Emitting Diode display of UP (the light is switched on by
42	MCU MUTE	O	MCU MUTE (it is MYUTO operation at "L").
43	GND		GND
44	3.3V		3.3V
45	MODE	I	The change switch of MONITOR/INTERNAL/LINE/Media Interface Connector.
46	(NO USE)	O	GND
47	INH	O	Prohibition of an analog input (it forbids by "H").
48	MIC/LINE	O	An input change of Media Interface Connector/LINE. H: Media Interface Connector, L:LINE.

PACKING-1

Assembly Method

- 1 Factory-shipped condition
 FUNCTION SELECTOR dial → LINE
 INPUT LEVEL adjustment dial → MIN
 PHONES LEVEL adjustment dial → MIN
 DIGITAL IN COAX/OPT selector → OPT (Rear side)
 WIN/MAC selector → WIN (Bottom side)
- 2 Serial No. of LABEL(POS) AS is stuck on CASE (R).
- 3 A set is put into POLY BAG, and a tape is stuck and it fixes.
 It is staging the printing side of POLY BAG, putting in a set,
 and bending a portion to CASE (R) side not much.

Parts Number	Parts Name
29362765	LABEL(POS)AS
29100097-1A	POLY BAG(350 X 250)
29110149	TAPE(SEROHAN)

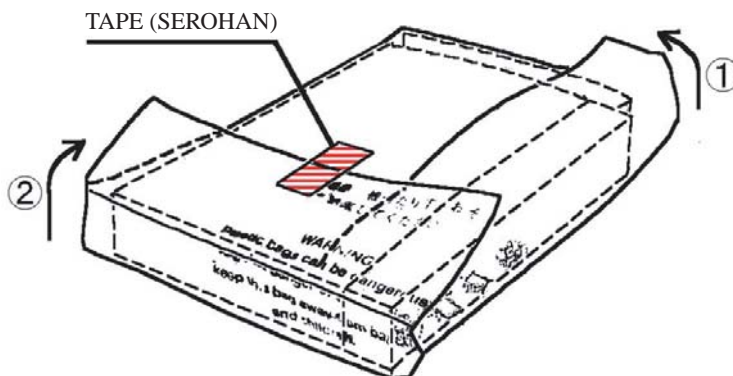
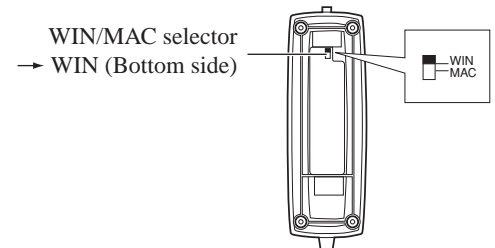
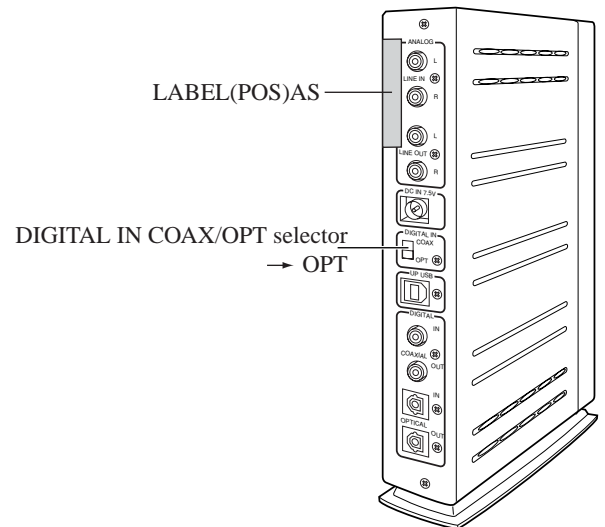
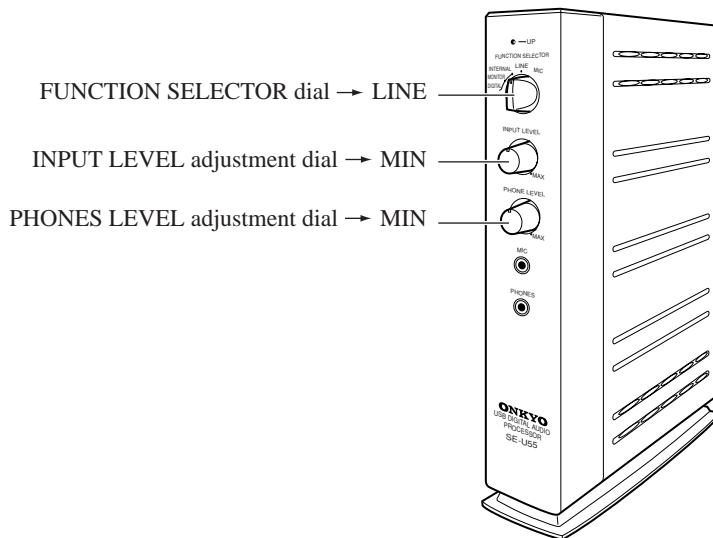

PACKING-2

Assembly Method

- 4 It puts in in the order of INS MANUAL J(SE-U55),INS MANUAL J(CarryOnMusic), WRANTY CARD,CD-ROM(SE-U55),CORD AS(NCS-1P150),CORD AS(USB-1M), PIN CORD AS into POLY BAG, and fixes on a tape.
*) POLY BAG is turning a character side down.

Parts Number	Parts Name
29100097-1A	POLY BAG(350 X 250)
28343006	INS MANUAL J(SE-U55)
29343043	INS MANUAL J(CarryOnMusic)
292163	CD ROM(SE-U55)
29365075B	WRNTY CARD
2050066	CORD AS(NCS-1P150)
2010391	CORD AS(USB-1M)
2010385	PIN CORD AS(0.8MT)
29110149	TAPE(SEROHAN)

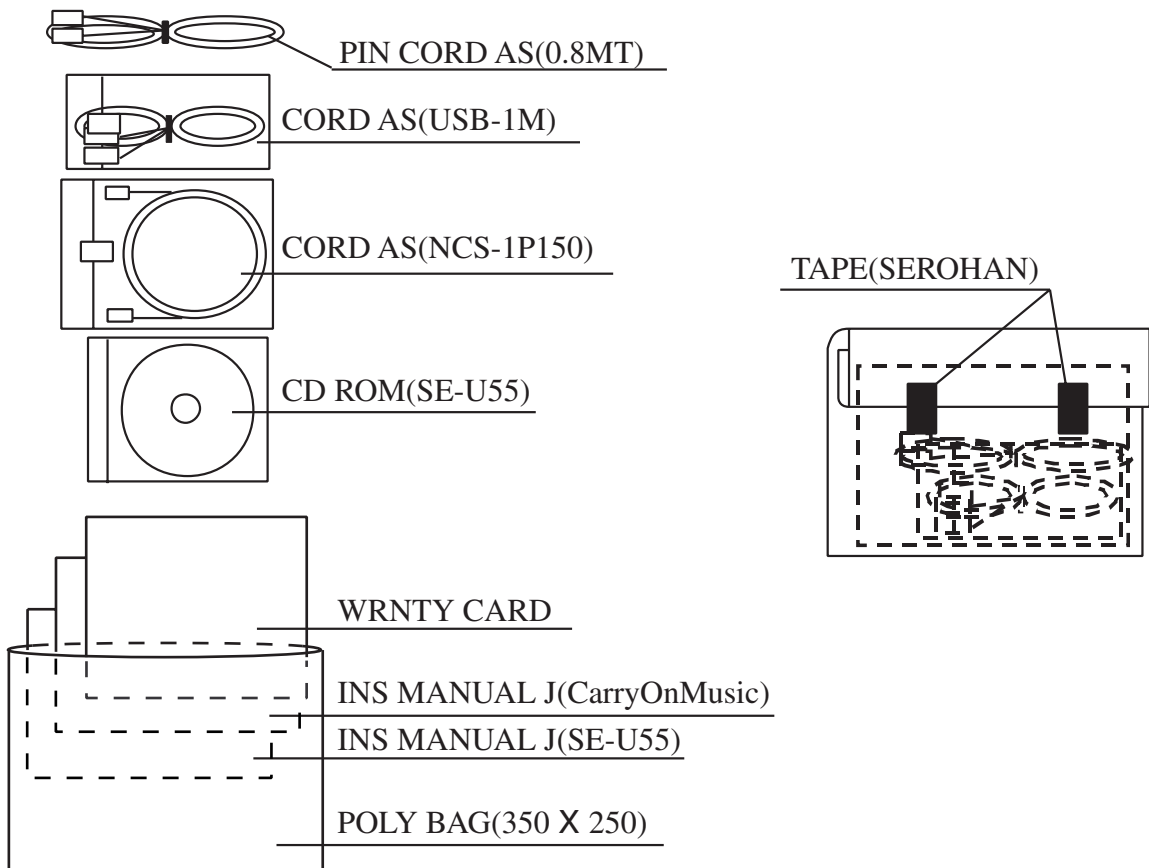

Packing-3

Assembly Method

- 5 Put the unit into assembled PAD (IN).
- 6 Assemble CARTON (IN).
- 7 Put PAD (IN) AS into assembled CARTON (IN).
- 8 Put Catalog AS into assembled CARTON (IN).

Parts Number	Parts Name
29091959	PAD (IN)
29053665A	CARTON (IN)

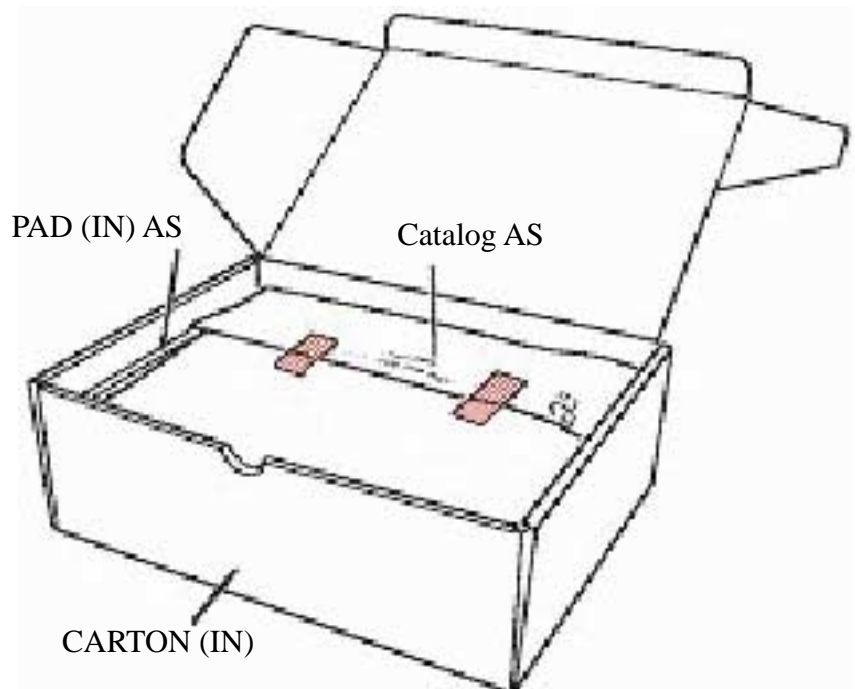
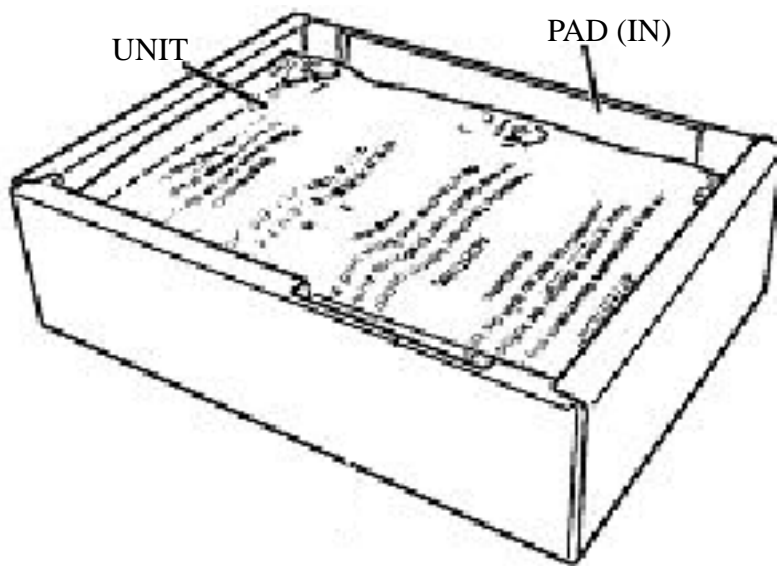

Packing-4

Parts Number	Parts Name
29362778A	LABEL(D)
29053666	CARTON(OUT)
29095891	SHEET(D)

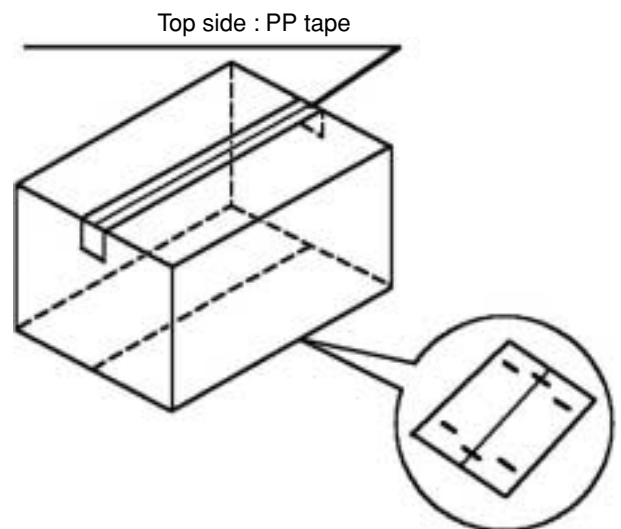
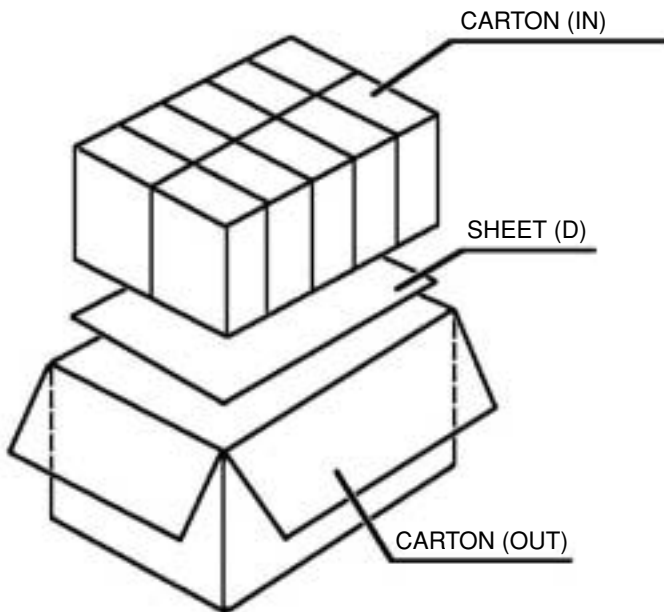
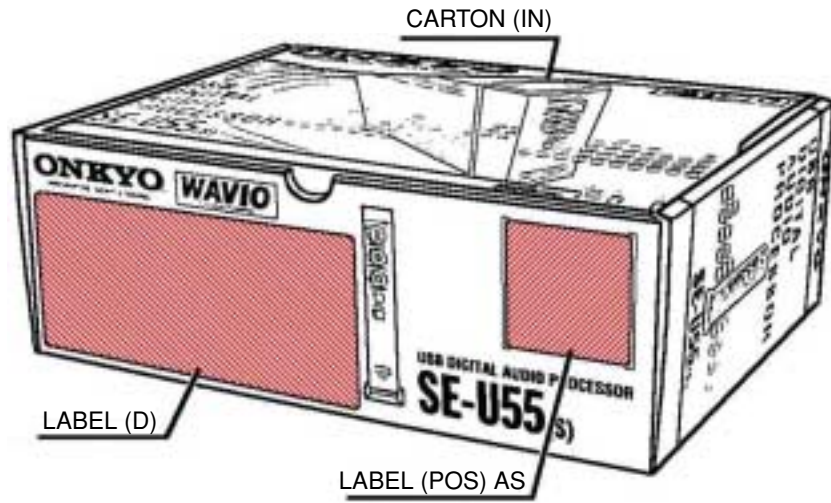

ONKYO CORPORATION

Sales & Product Planning Div. : 2-1, Nisshin-cho, Neyagawa-shi, OSAKA 572-8540, JAPAN
Tel: 072-831-8111 Fax: 072-833-5222

ONKYO U.S.A. CORPORATION

18 Park Way, Upper Saddle River, N.J. 07458, U.S.A.
Tel: 201-785-2600 Fax: 201-785-2650 E-mail: onkyo@onkyousa.com

